

# SARAH



A-1-SAR-TBL-WH

Lazy Susan

**1**

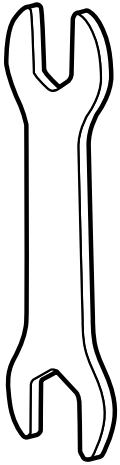

**A-M8-40MM-BOLT**  
  
**12x**

**A-M8-NUT-CAP-WH**  
  
**12x**

**A-M8-NUT**  
  
**12x**

**A-M8-WASHER**  
  
**12x**

**A-M8-SPRING-WASH**  
  
**12x**

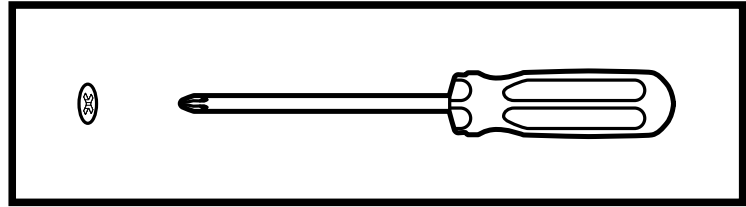

**2**

**4x**

**A-M8-40MM-BOLT**  
**A-M8-WASHER**  
**A-M8-NUT**

**A-M8-40MM-BOLT**  
**A-M8-WASHER**  
**A-M8-NUT**

**A-M8-TABLE-FEET**

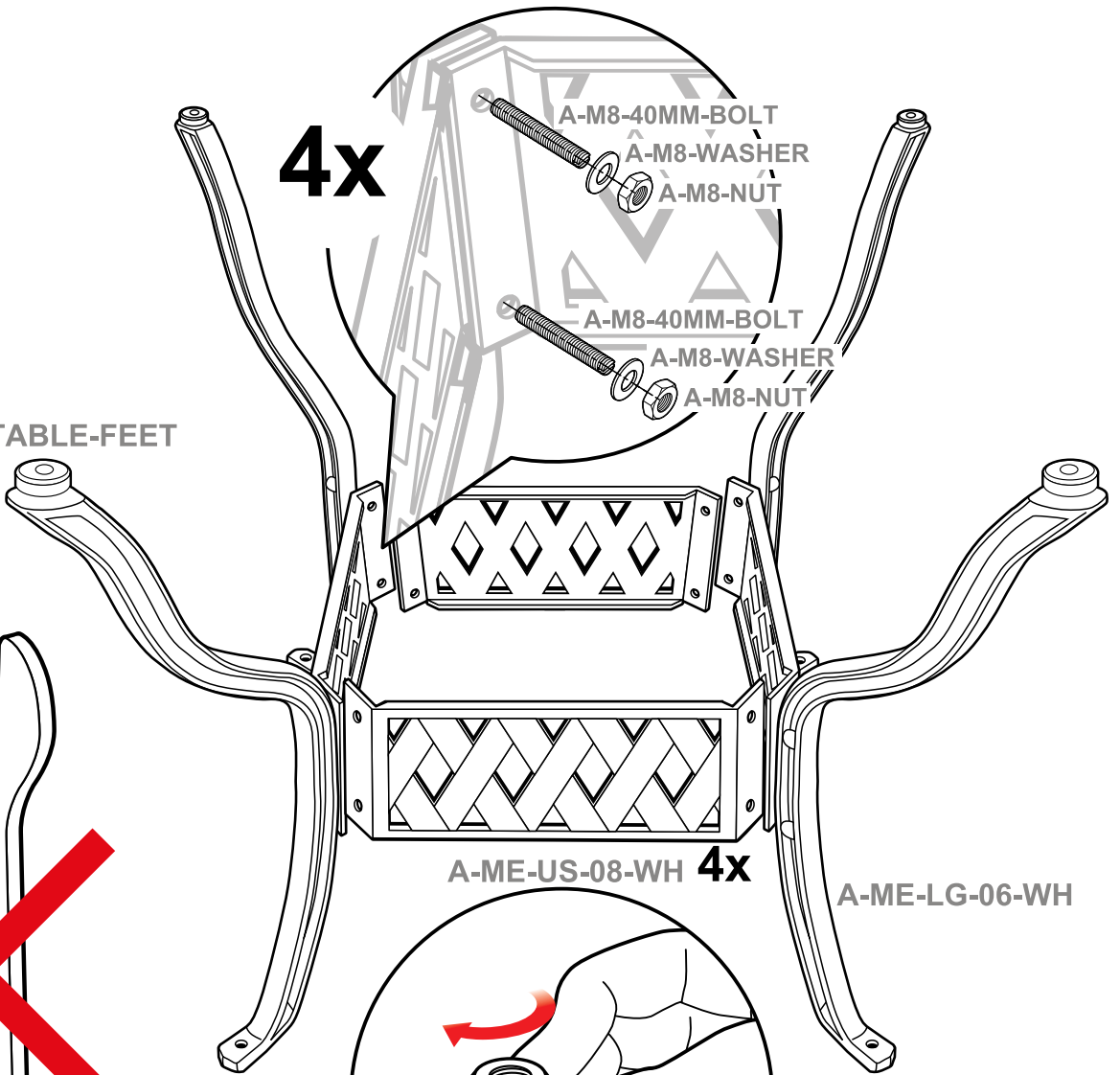

**A-ME-US-08-WH 4x**

**A-ME-LG-06-WH**

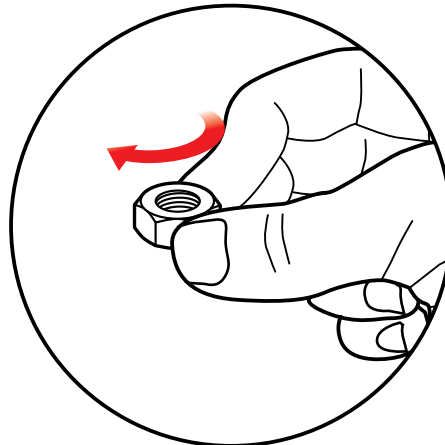
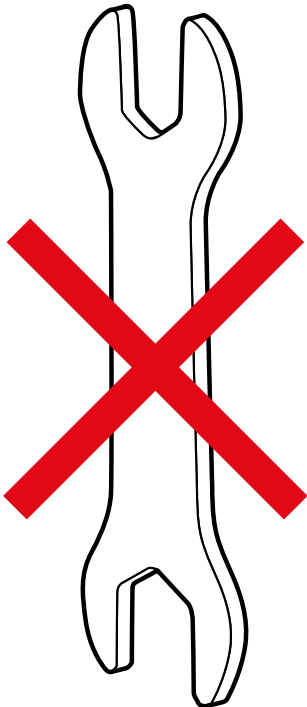

3

4x

A-M8-NUT-CAP-WH

A-M8-NUT-CAP-WH

A-ME-TT-08-WH

A-M8-NUT-CAP-WH

A-M8-NUT

A-M8-SPRING-WASH

A-M8-WASHER

4x

A-M8-40MM-BOLT

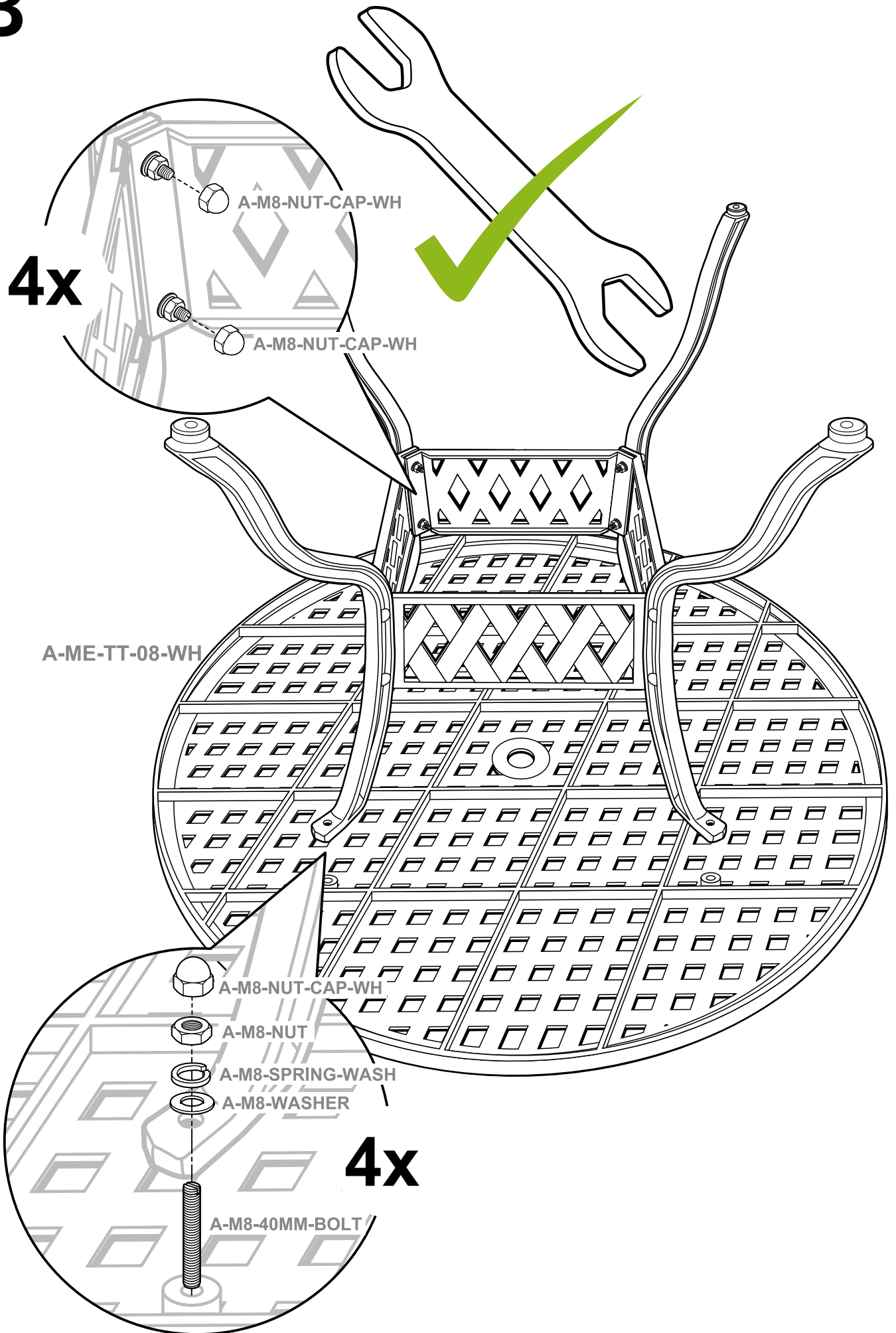

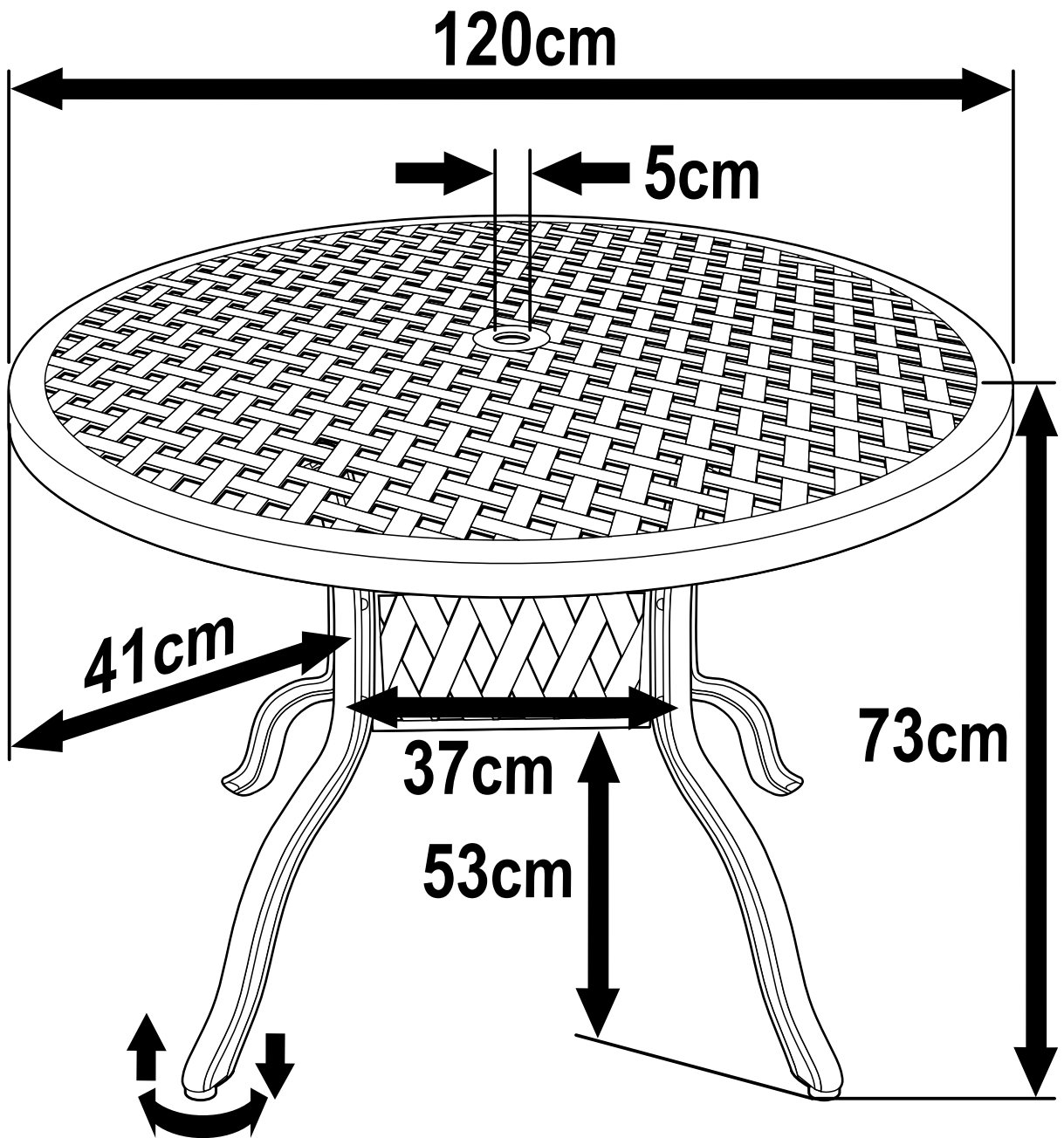

Lazy Susan